

BEST KIT-OF-PARTS GUIDE

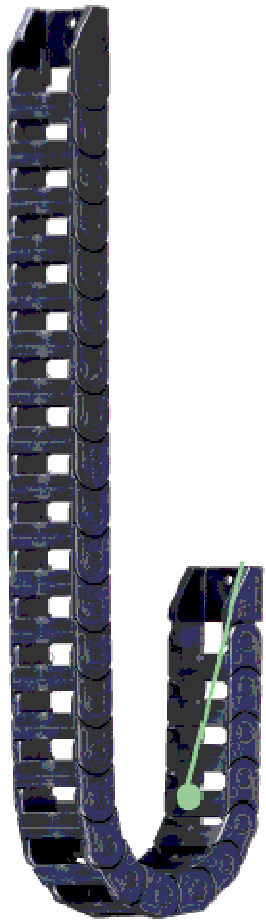

EZ Energy Chain System®
with 2 Mounting Brackets
(77 Individual Links)

igus

ALSO KNOWN AS:

WARNING

ROBOTICS "CRACK" !!

VERY ADDICTIVE !

DANGER

Authorized
Personnel Only



BEST KIT-OF-PARTS GUIDE

Version 02: Carriages with threaded boss

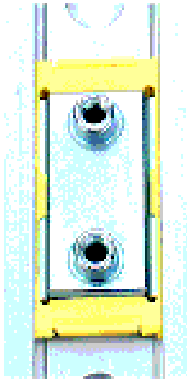

Data:

Part No. carriage	NW-02-27(P)
Part No. rail	NS-01-27
Rail weight	3.01 oz. (290 g/m)
Carriage weight	.44 oz. (12.5 g)
Max. rail length	140 in (3560 mm)
Standard bore pattern	symmetrical (C5 = C6)
Preload available	Yes
for reduced clearance	.22 lbs (1N)

**Dryline® Low Profile
Linear Guide system x2**

**Dryline® S 1/4" Diam. Hard Anodized
Aluminum Shaft, 18" Length x2**

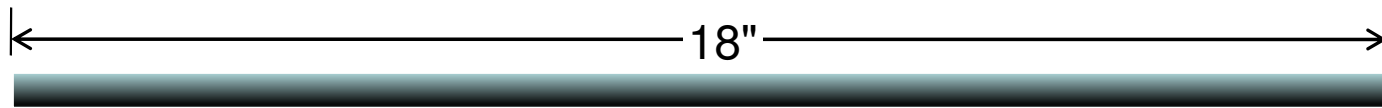

**igubal® Flange
Mount Spherical
Bearing x6**



**igubal® Pillow
Block Mount
Spherical Bearing x6**



**igubal® 1/4" Rod
End Bearing x6**

igus

BEST KIT-OF-PARTS GUIDE

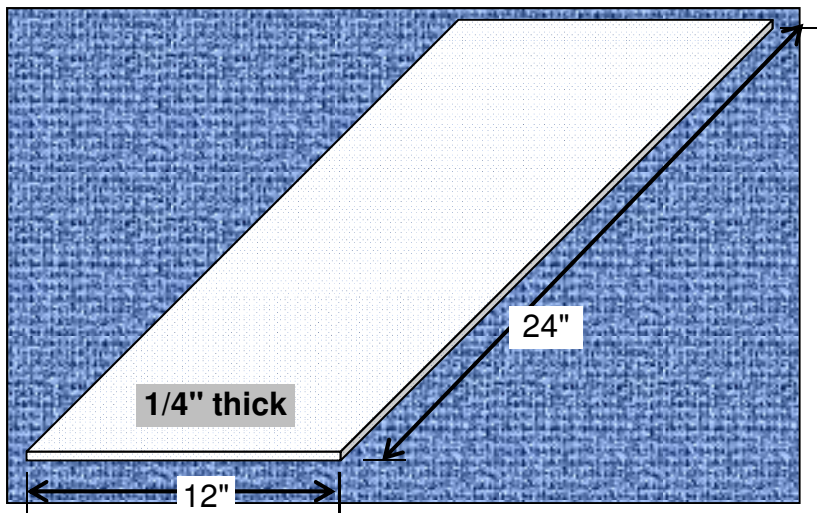

1/4" thick polypropylene sheet 12" x 24"

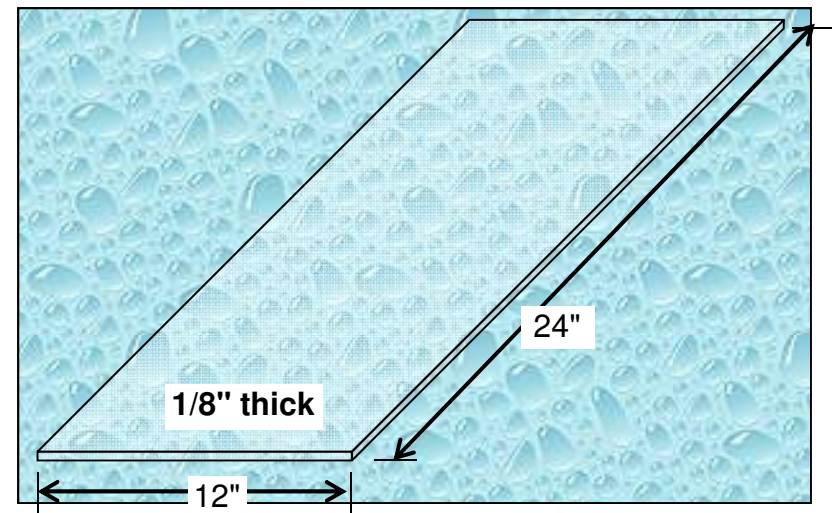

1/8" thick PVC sheet 12" x 24"

Plastic

BEST KIT-OF-PARTS GUIDE

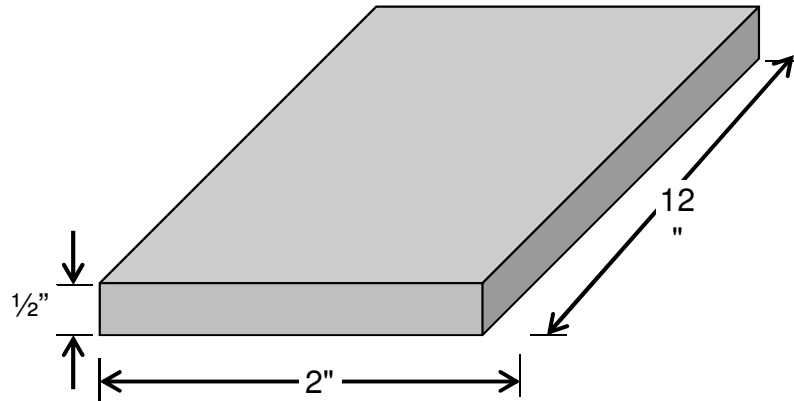

1/2" thick Aluminum Flat 2" x 12"

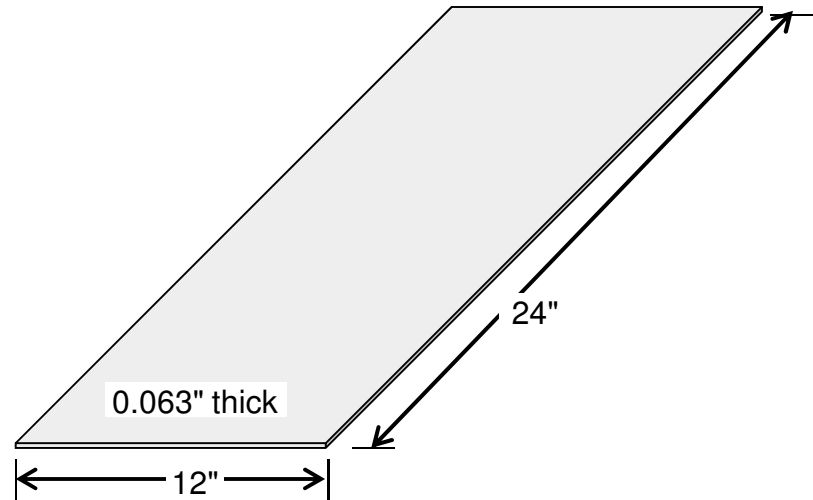

0.063" thick Aluminum sheet 12" x 24"

0.5" Diameter Aluminum Round, 24" long

0.25" Diameter Steel Round, 24" long x2

0.063" Diameter Piano Wire, 24" long x3

Metal

BEST KIT-OF-PARTS GUIDE

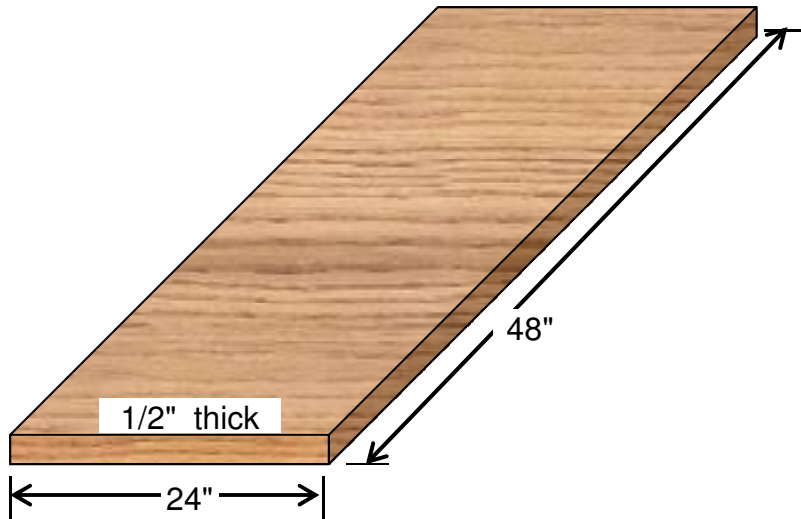

1/2" thick Plywood 2' x 4'

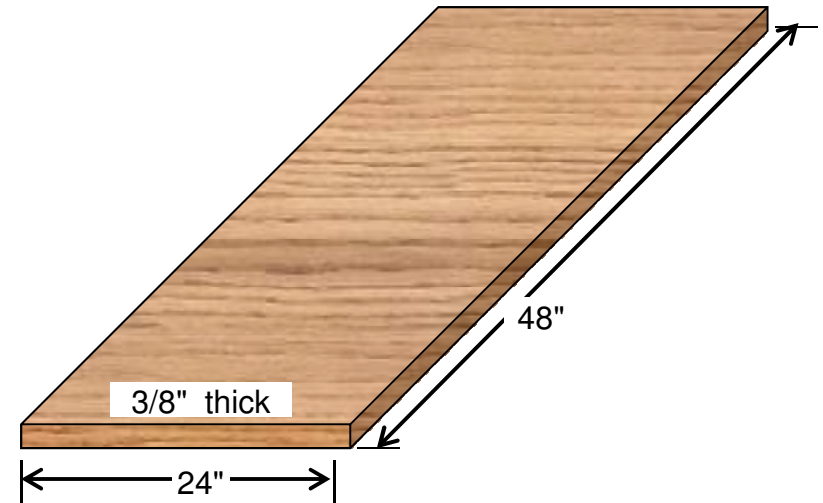

3/8" thick Plywood 2' x 4'

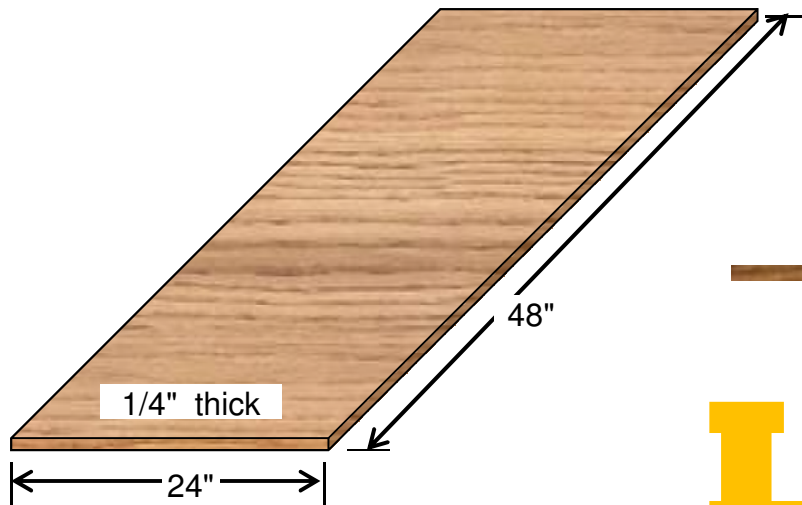

1/4" thick Plywood 2' x 4'



1" x 4" whitewood 2 ft long **x2**



1/4" x 48" hardwood dowel

Lumber

BEST KIT-OF-PARTS GUIDE

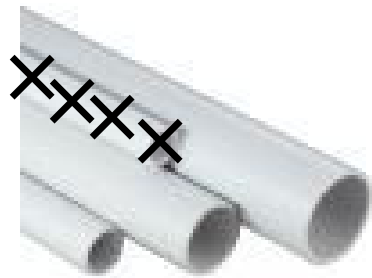

PVC

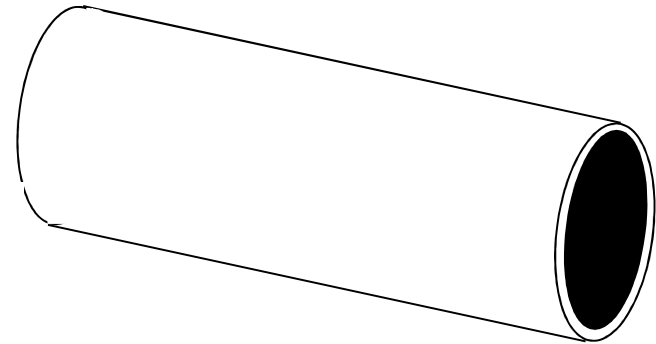

- 1/2" sched 40 PVC pipe x 5' **x4**
- 3/4" sched 40 PVC pipe x 5' **x2**
- 1" sched 40 PVC pipe x 5' **x2**



Regular PVC Cement,
4 oz or 8 oz

4" PVC Solid
Sewer Pipe x 3'



1/2" PVC 90 degree elbow **x10**



1/2" PVC tee **x10**



3/4" PVC 90 degree elbow **x10**



3/4" PVC tee **x10**



1" PVC 90 degree elbow **x6**



1" PVC tee **x6**

BEST KIT-OF-PARTS GUIDE



2.5" x 5/8", Iron
ZN, Corner Angle
Bracket **x4**



2" x 3/8", Iron
ZN, Flat Angle
Bracket **x4**

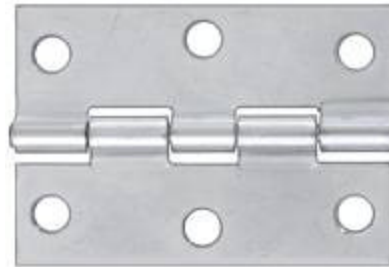

2.5"H x 1.69"W x
0.083" narrow hinge
w/removable pin **x2**

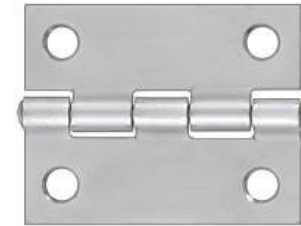

1.5"H x 1.41"W x
0.047" narrow hinge
w/nonremovable pin **x2**



Extension Spring for Heavy Doors



3/4" metal pipe
hanger tape, 24
Gauge, 10 ft.



6" x 6" Steel Turn-
table, 500 Pound
Capacity

Hardware

BEST KIT-OF-PARTS GUIDE



18 ga stranded copper wire, red insulation, single cond.

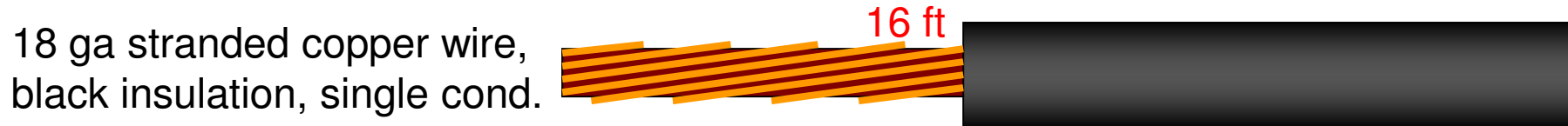

18 ga stranded copper wire, black insulation, single cond.



CAT-3 24guage, 4 twisted pairs

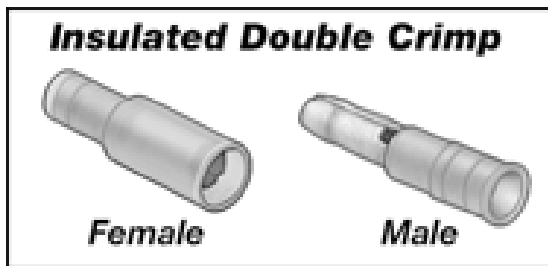

snap-plug terminals (bullet connectors), insulated, male **x16**

snap-plug terminals (socket for bullet connectors), insulated, female **x16**

Electrical

BEST KIT-OF-PARTS GUIDE



Rotary potentiometer
10kohm, 6mm shaft **x2**

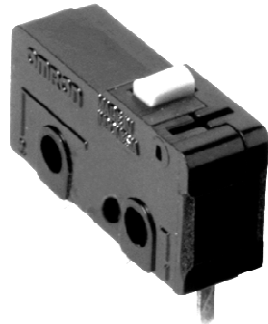

sub-mini snap acting switch, SPDT,
0.1 amp (min) **x4**



Heat shrink tubing,
1/4" OD expanded,
2:1 ratio, polyolefin,
black **2 ft**



11" long x 0.18" wide
nylon cable tie **x10**



4" long x 0.1" wide
nylon cable tie **x20**

Electrical

BEST KIT-OF-PARTS GUIDE



vinyl electrical tape,
3/4" Wide, 60 ft



friction tape,
3/4" Wide, 60 ft



all purpose duct tape,
2" Wide, 60 yd



Painter's tape,
1" Wide, 60 yd



carpenters wood
glue, 4 oz



5 minute epoxy 1 oz

Tapes & Adhesives

BEST KIT-OF-PARTS GUIDE

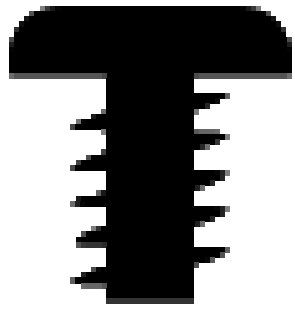

**PAN
HEAD**

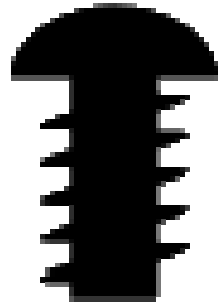

**ROUND
HEAD**

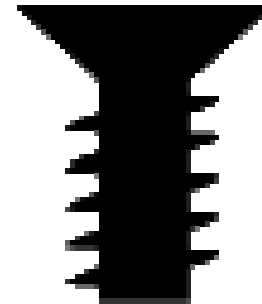

**FLAT
HEAD**

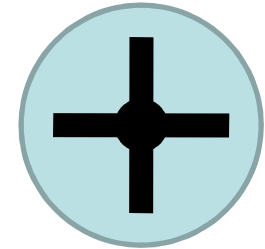

**Phillips
Drive**

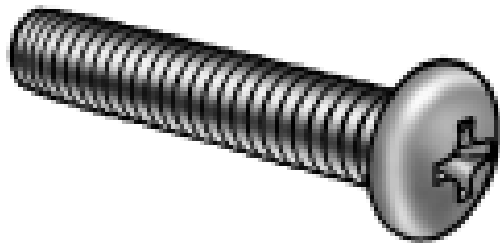

MACHINE SCREWS (BOLTS)

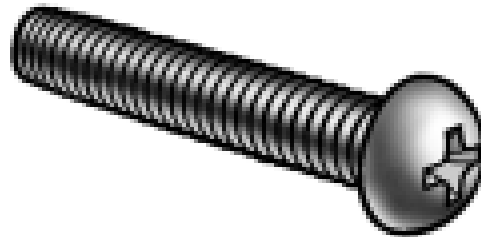

WOOD SCREW

Threaded Fasteners

BEST KIT-OF-PARTS GUIDE

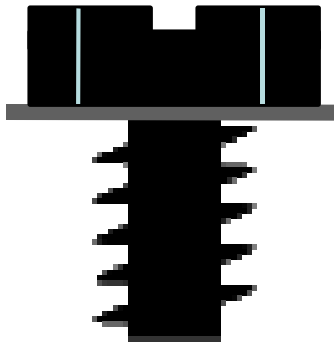

**HEX
HEAD**

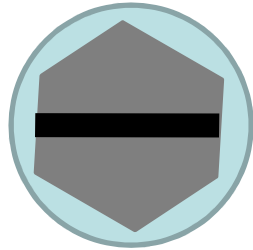

**Hex /
Slotted
Drive**

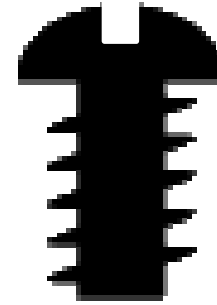

**ROUND
HEAD**

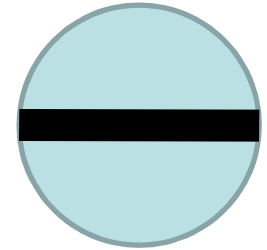

**Slotted
Drive**

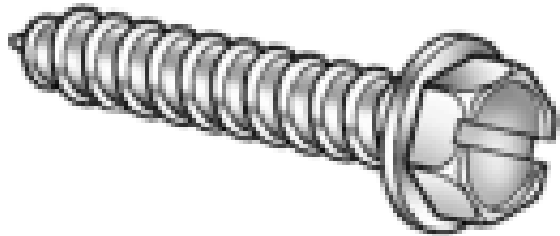

SHEET METAL SCREW
(WORKS WELL IN WOOD!)

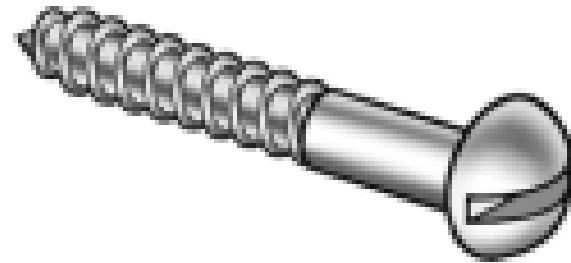

WOOD SCREW

Threaded Fasteners

BEST KIT-OF-PARTS GUIDE

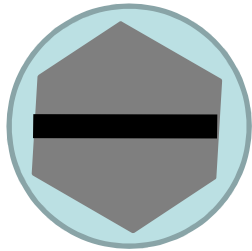

**Hex /
Slotted
Drive**

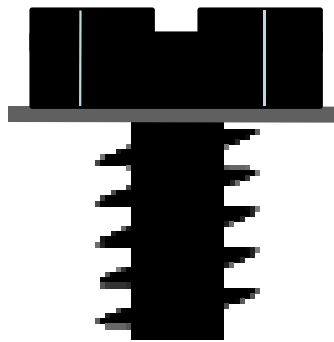

**HEX
HEAD**

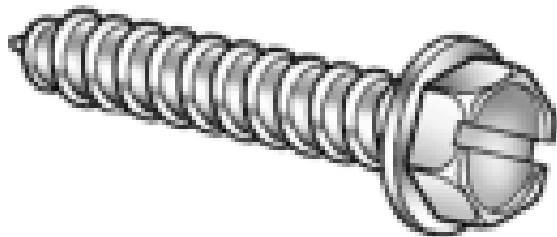

NOTE: Use of a *slotted screwdriver* is ***NOT RECOMMENDED!!***

The slot is shallow and strips out easily!
Use a Nut Driver on the hexagonal head!



Threaded Fasteners

BEST KIT-OF-PARTS GUIDE



1/4-20 Threaded Rod, 3' long



1/4-20 Hex Nut, steel **x25**



1/4 SAE flat washer, steel **x25**



1/4 med. split lock washer, steel **x25**

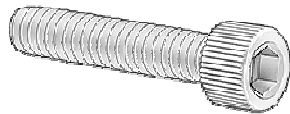

1/4-28 x 1" screw, nylon **x6**



10-32 x 1-1/2" machine screws, steel, **round** head, phillips **x25**



#10-32 machine screw nut, steel **x25**



#10 flat washer, steel **x25**



#8-32 x 1-1/4" machine screws, steel, **pan** head, phillips **x100**



#8-32 machine screw nuts, steel **x100**



#8 med. split lock washer, steel **x25**



10-32 x 3/4" screw, socket head **x6**

Threaded Fasteners

BEST KIT-OF-PARTS GUIDE

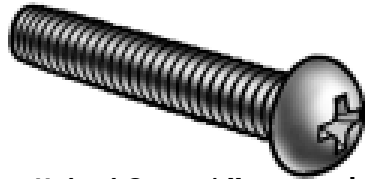

#4-40 x 1" machine screws, steel, **round** head, phillips **x25**



#4-40 machine screw nut, steel **x25**

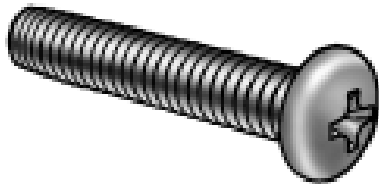

#2-56 x 1" machine screws, **pan** head, phillips, stainless **x10**



#2-56 machine screw nuts, 3/16 x 1/16, steel **x10**



#2 flat washer, steel **x10**

Threaded Fasteners

BEST KIT-OF-PARTS GUIDE

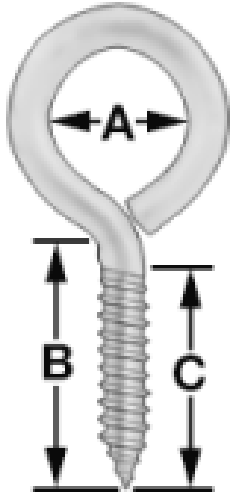

wood screw eyebolts,
0.192 wire dia x .97
shank x .75 thread x
.27 id, steel **x10**

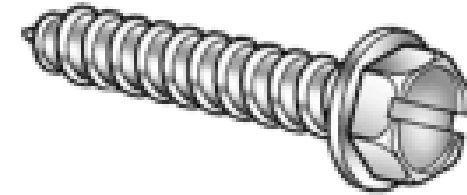

#8 X 1" sheet metal
screw, steel, hex head
x100

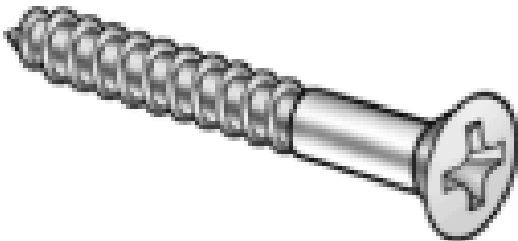

#6 X 1" wood screws,
steel, flat head **x100**

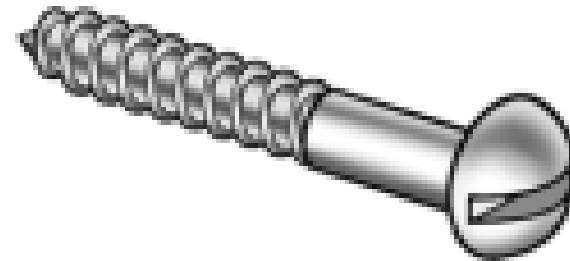

#4 X 3/4" wood
screw, steel,
slotted drive,
round head **x25**

Threaded Fasteners

BEST KIT-OF-PARTS GUIDE

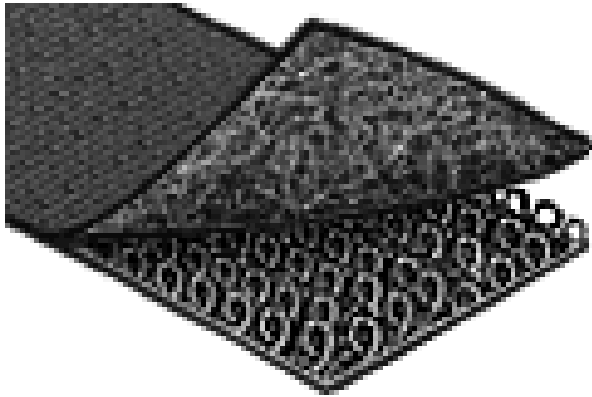

3/4" nylon sticky back hook and loop fastener **5 ft**

#18 twisted nylon seine twine, **225-250 ft long**

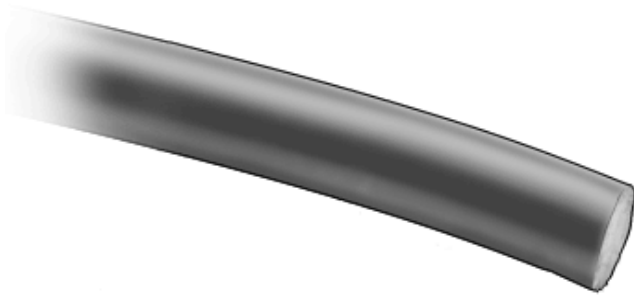

1/4" polypropylene covered shock cord (color optional) **4 ft**

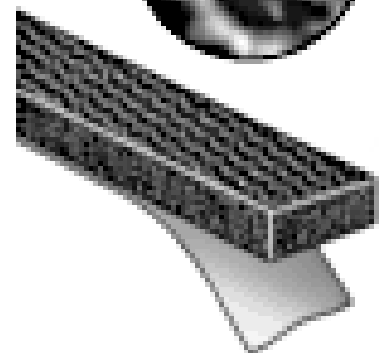

3/8" thick, 1" wide, adhesive backed, gum rubber strip **2 ft**

Miscellaneous

BEST KIT-OF-PARTS GUIDE



bicycle inner tube
(26" X 1.5" - 2.0")



60x65" universal brake
cable with housing
(white or black)



#10 Rubber Band (1/16"
wide x 1-1/4" long) **x25**
#32 Rubber Band (1/8"
wide x 3" long) **x25**



1 1/4" long paper clips,
0.033 dia wire (No. 1
Regular) **x100**



VEX motor mount kit
(4 mounts+ screws)

Miscellaneous